



# CITY

60002





1

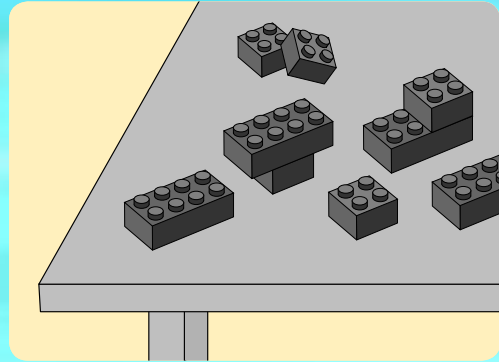
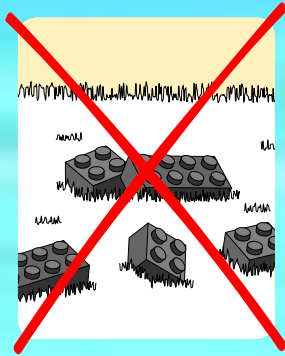

2

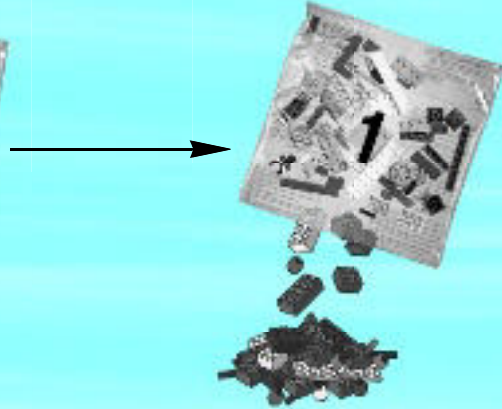





1x



4x



1x



1x

1



2



3



4



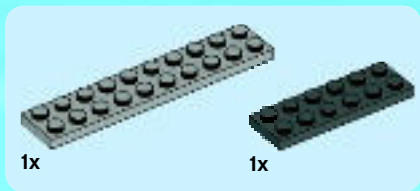

1

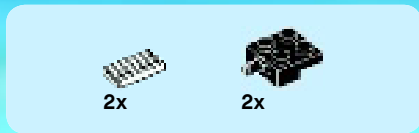
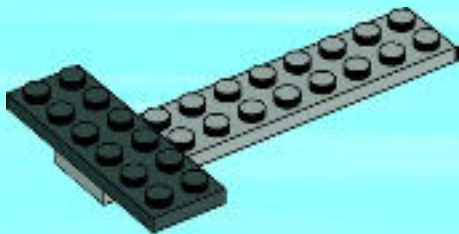

2





1x

**3**

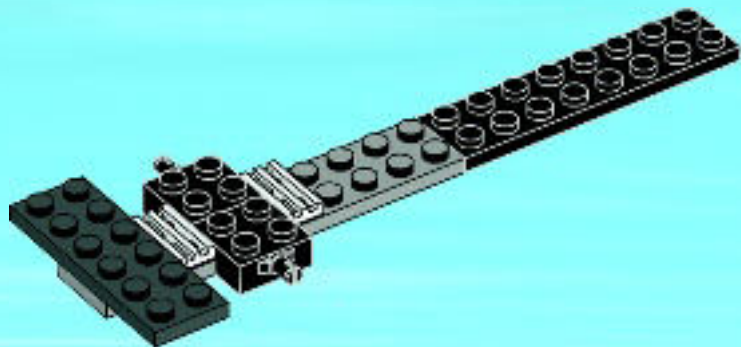

8





1x

4

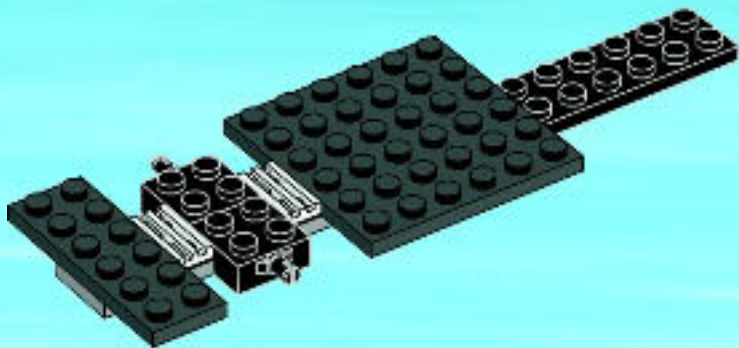



2x



2x

5

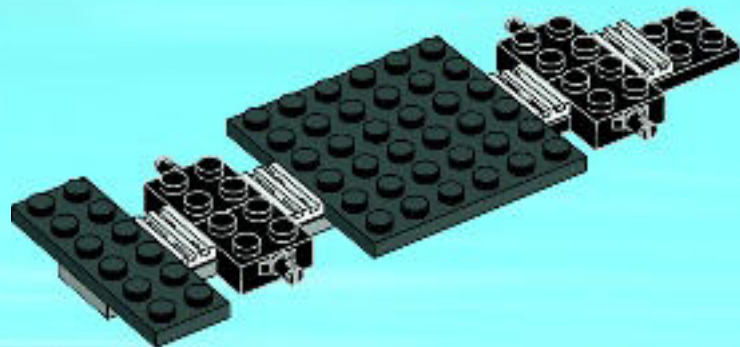



1x

6

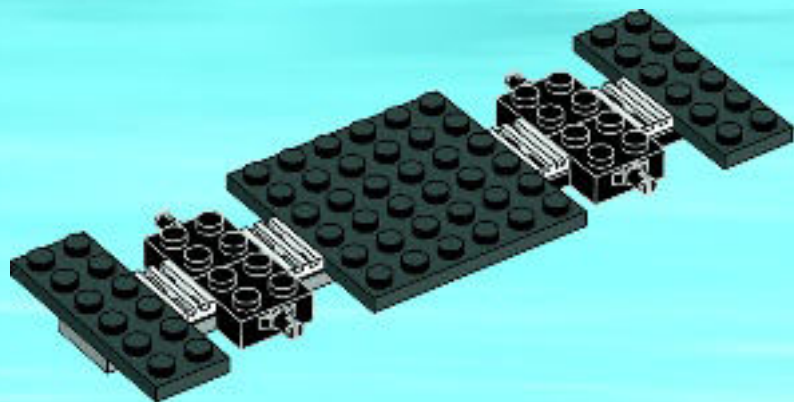



2x

7

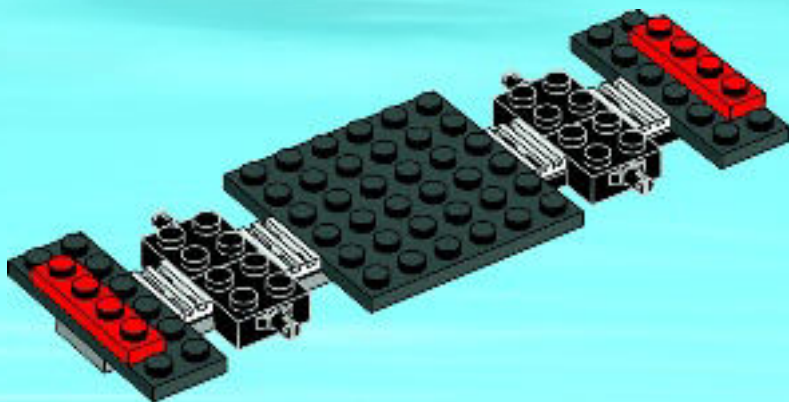

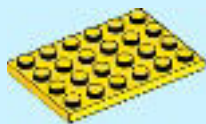

2x

8

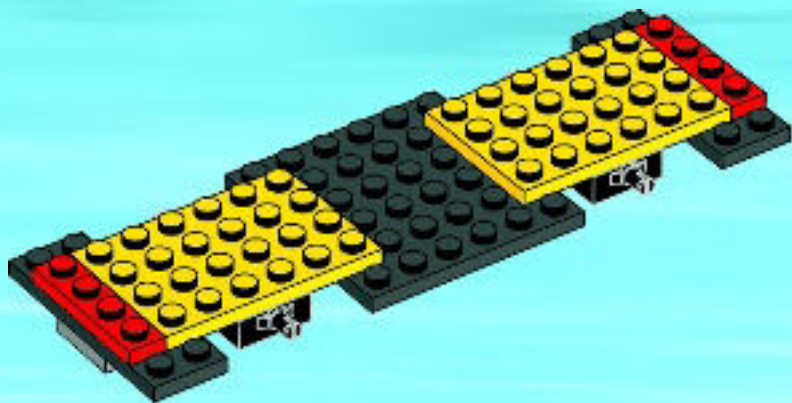



4x

9

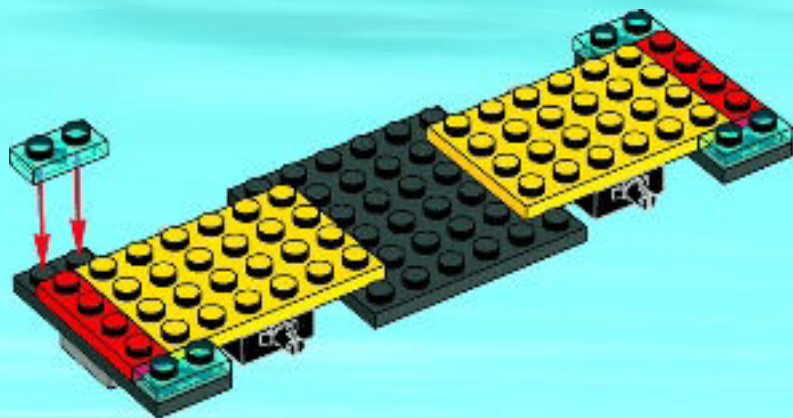



6x

10

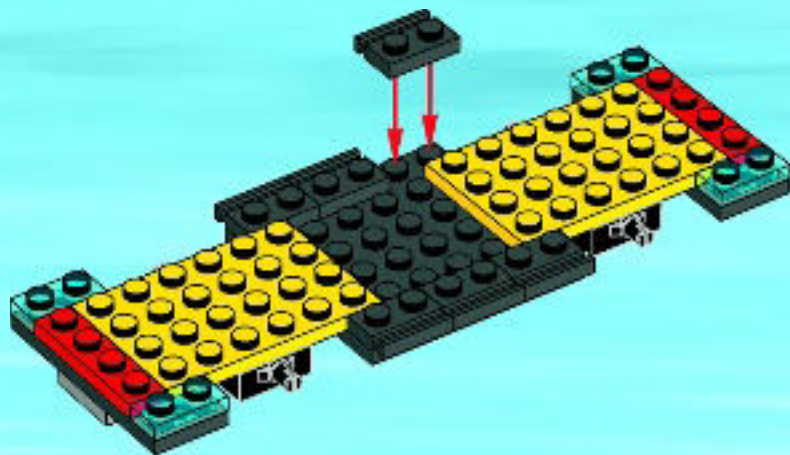



2x

11

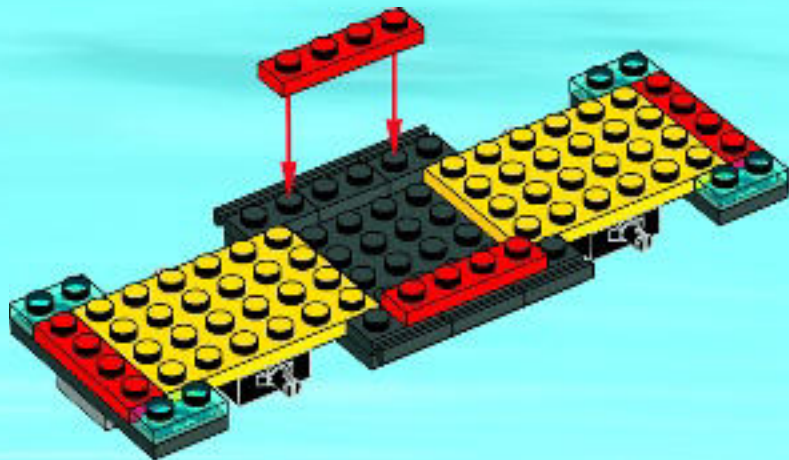





1x



2x

# 12

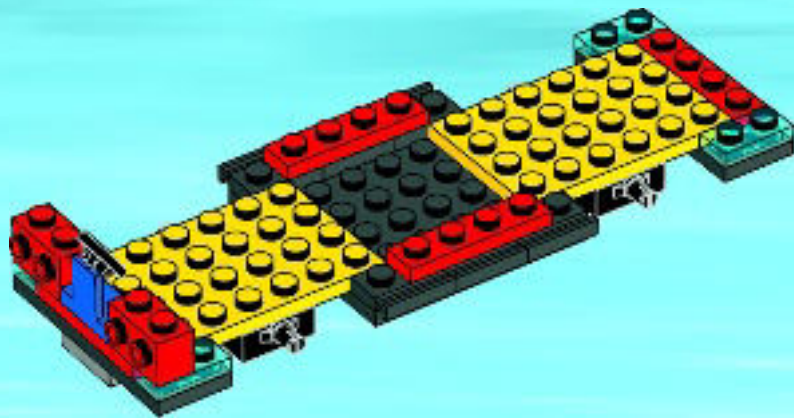



4x

# 13

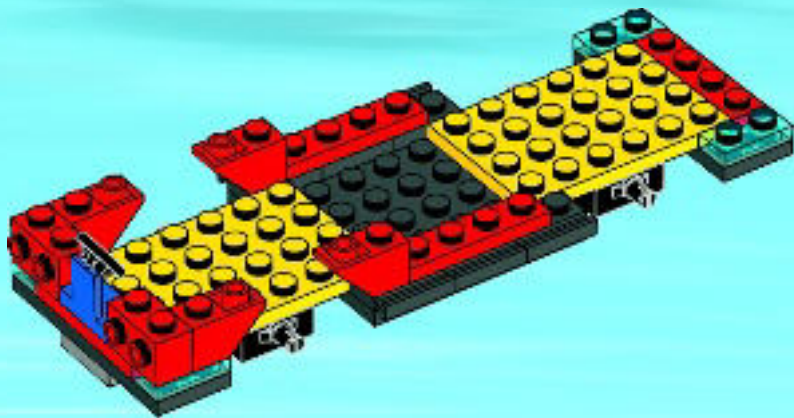



4x

14

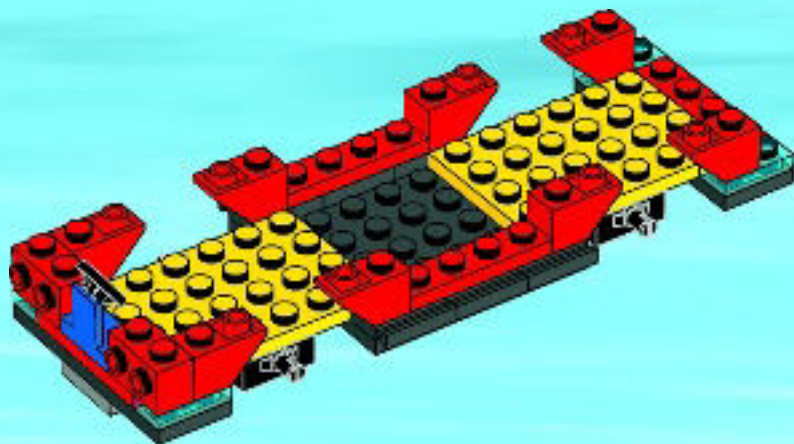



2x

15

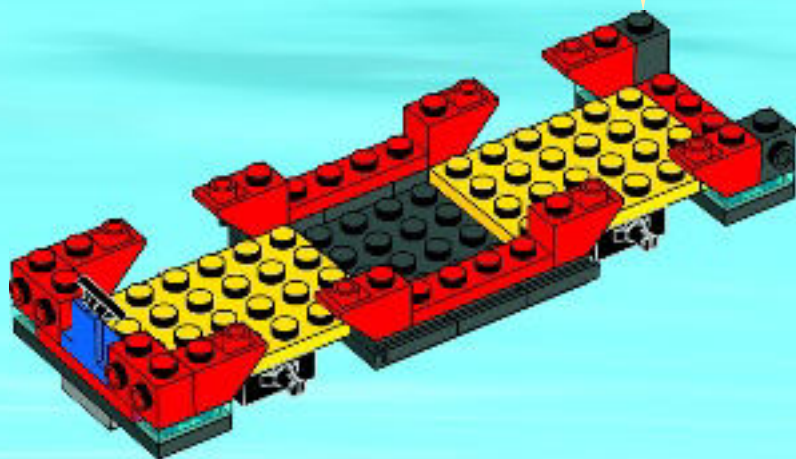



1x



2x



2x



2x



2x



2x



1x

# 16

## 1

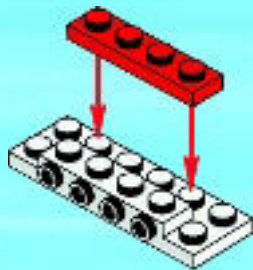

## 2

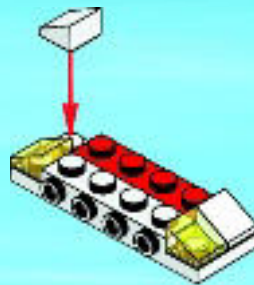

3

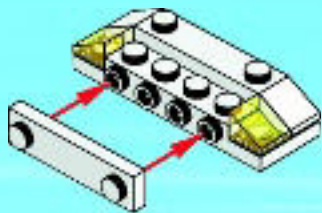

4



5

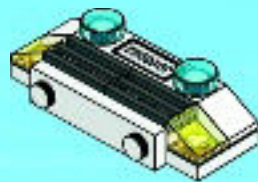

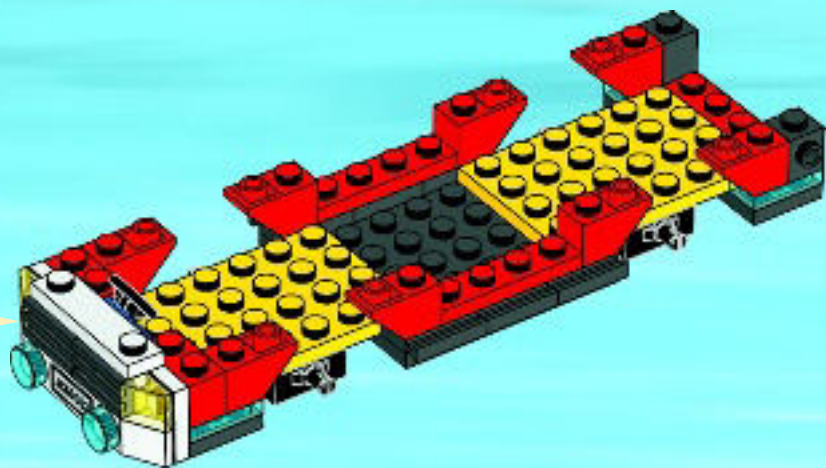



2x

17

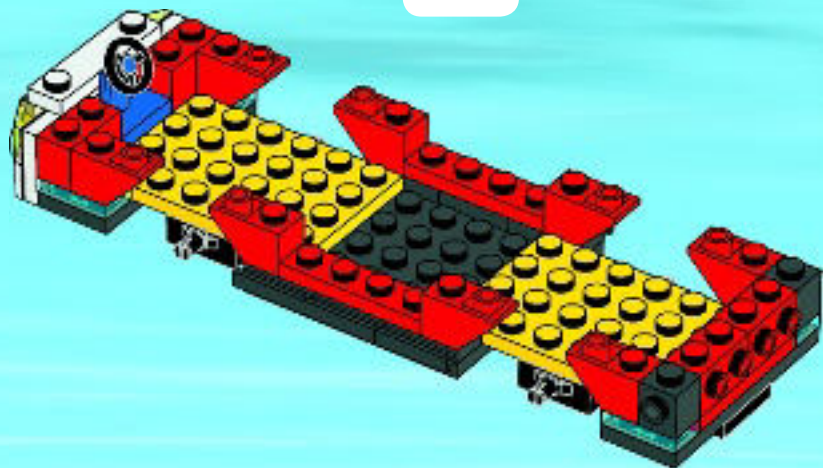





2x



2x

# 18

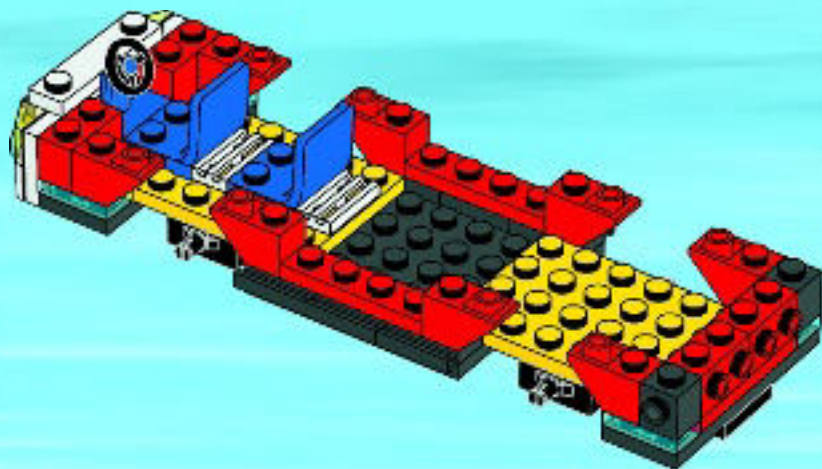



4x

19

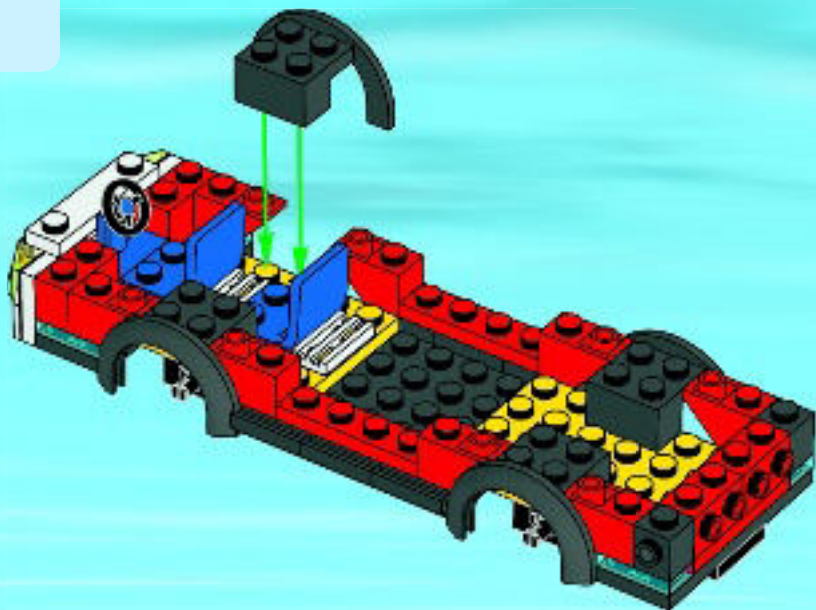



2x

20

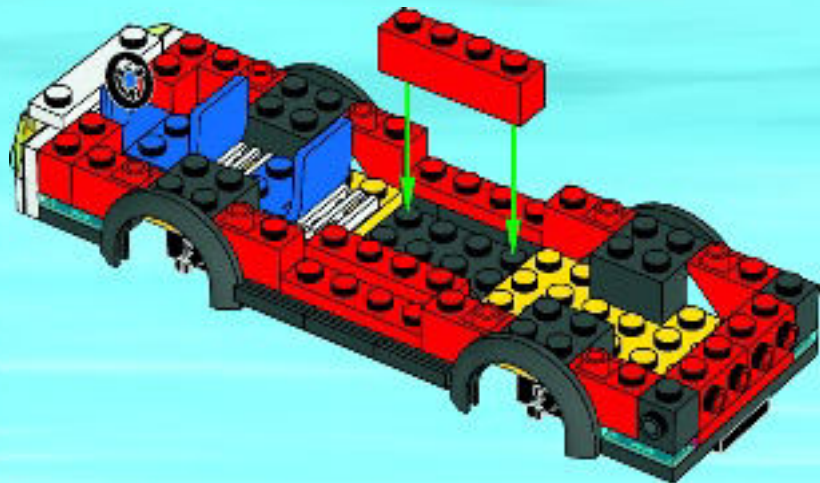



1x

21

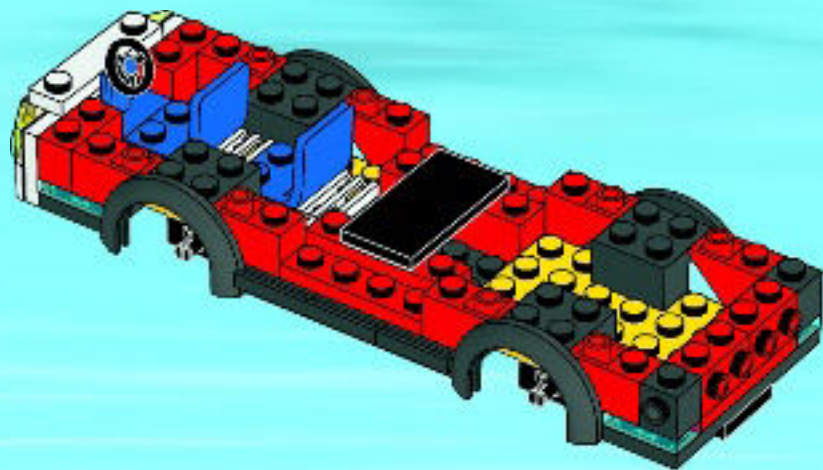



2x

22

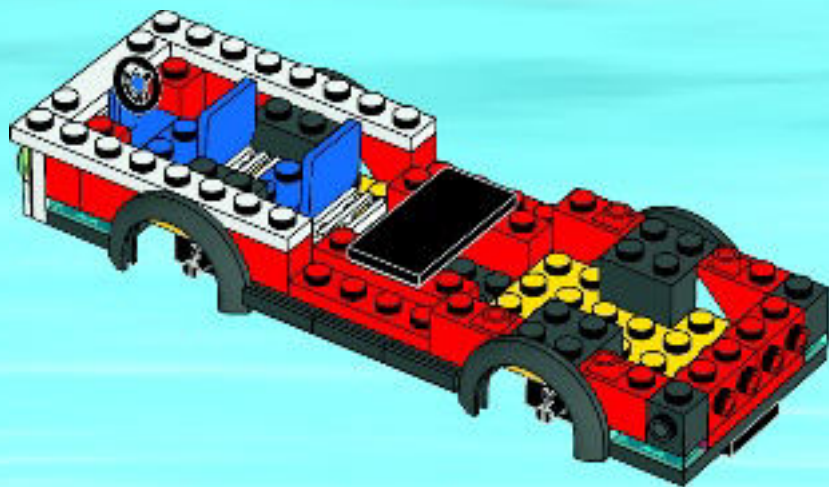



1x



1x



2x



2x



1x



1x



2x

# 23

## 1

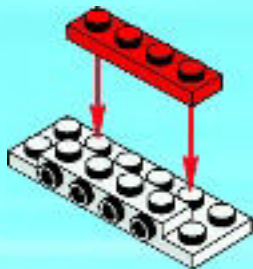

## 2

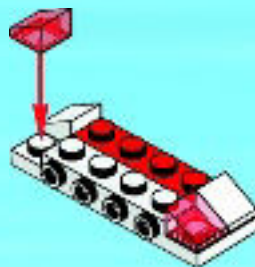

3

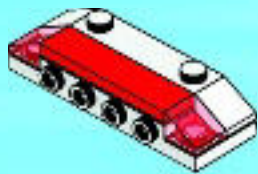

4



5



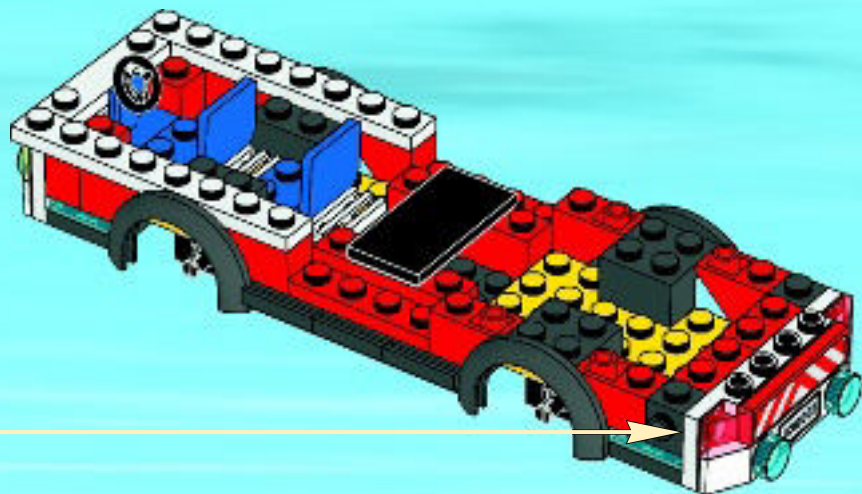





2x

24

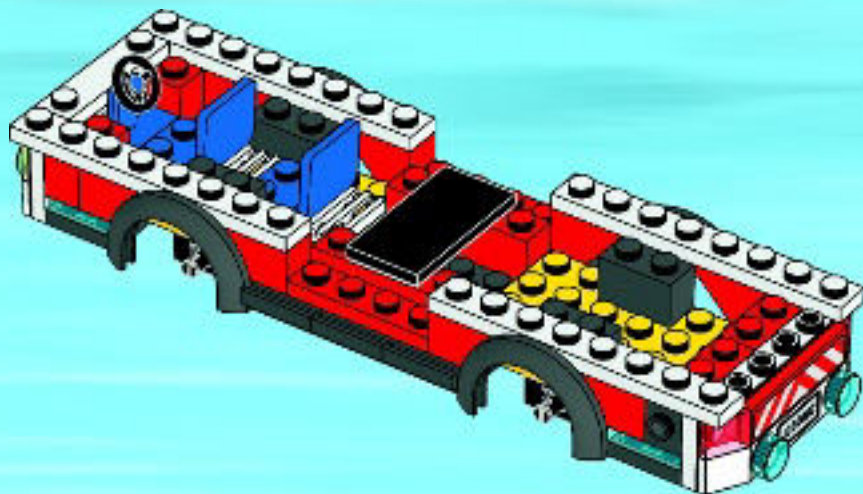



2x

25

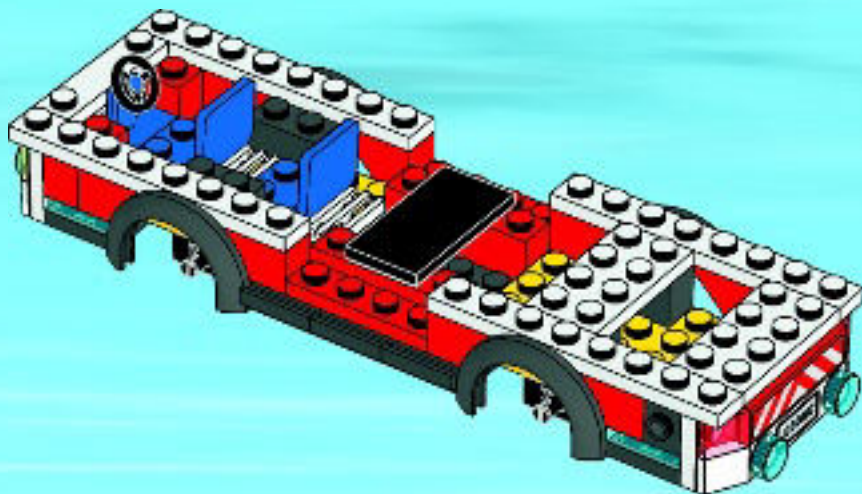



2x

26

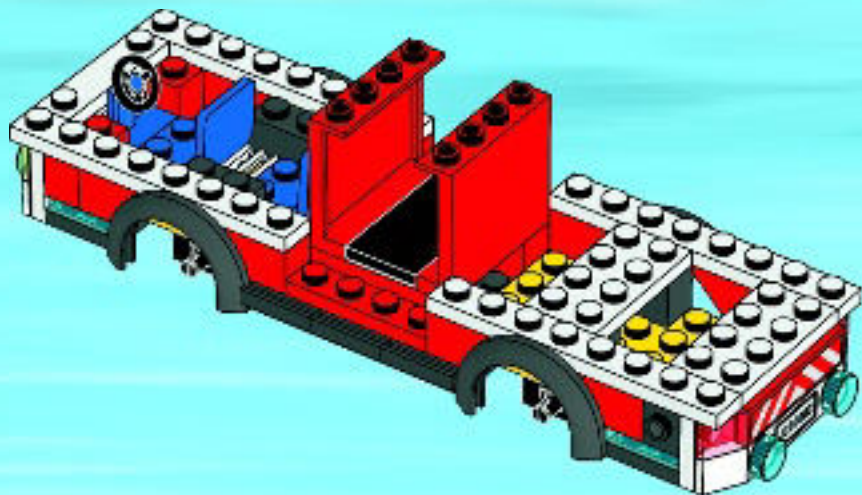



2x



2x

# 27



2x

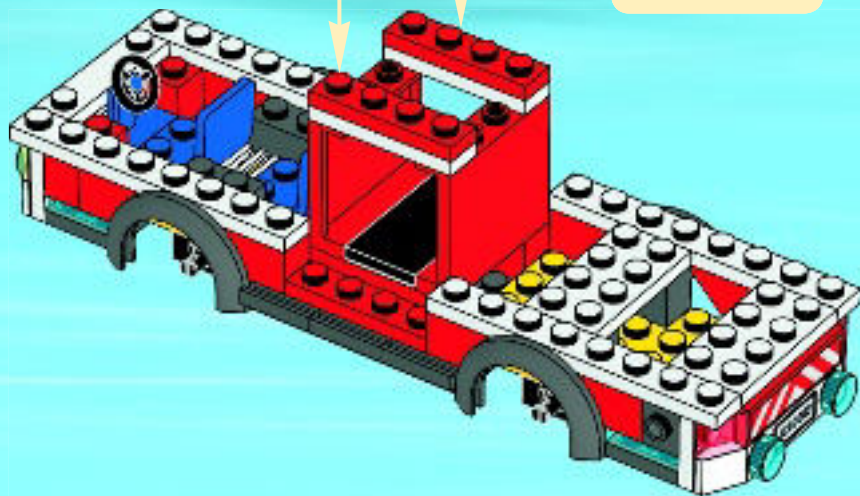

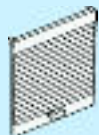

2x

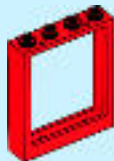

2x

28

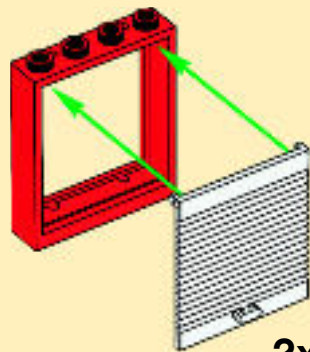
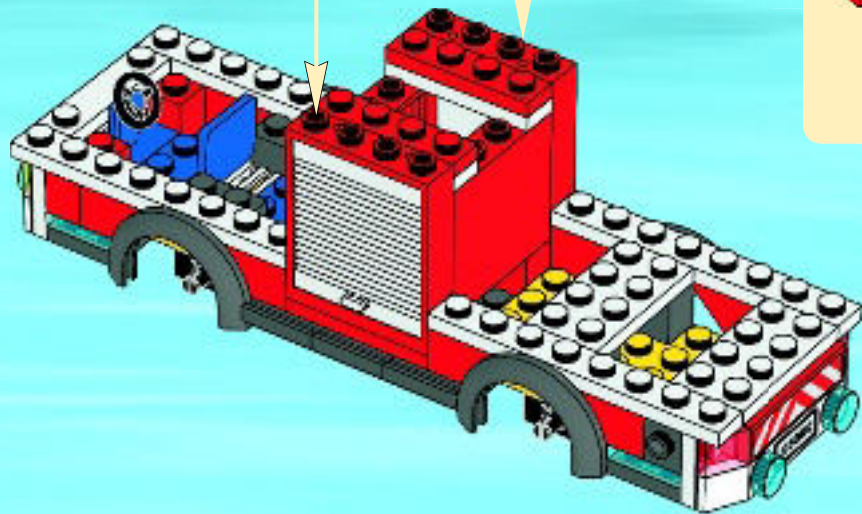

2x

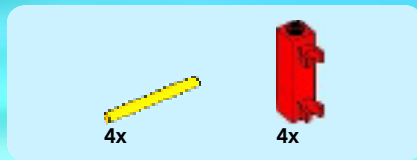
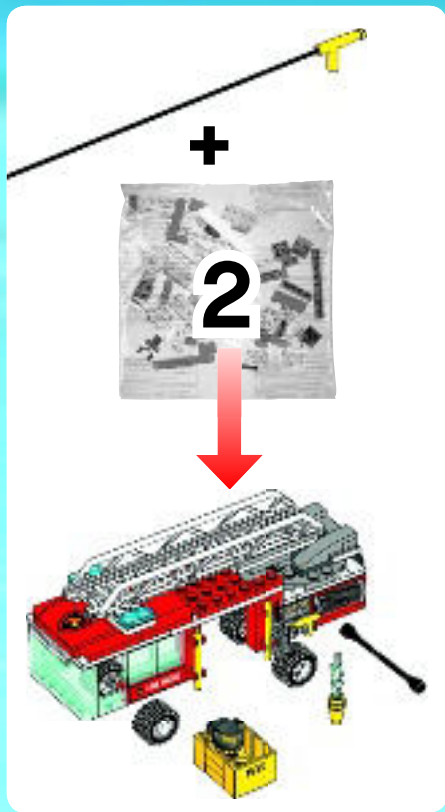

29

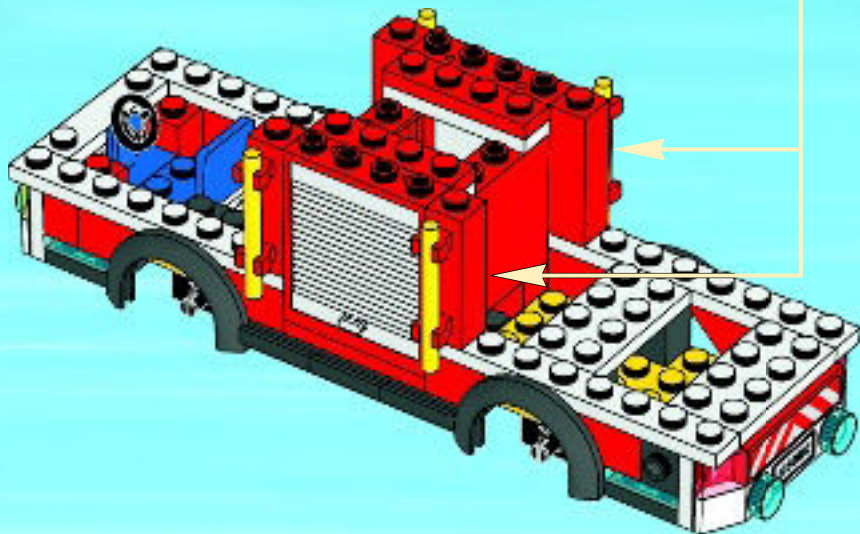
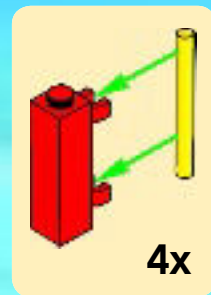



2x

# 30

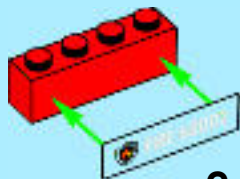

2x

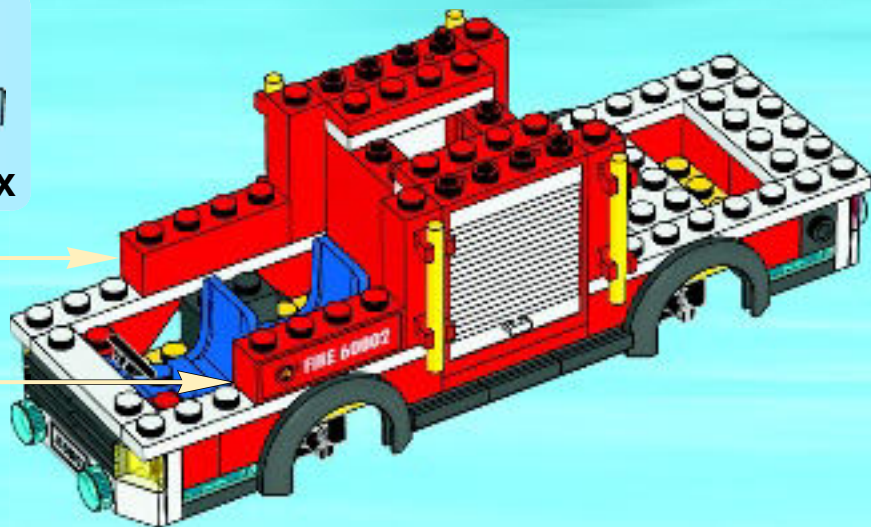



2x



4x

# 31

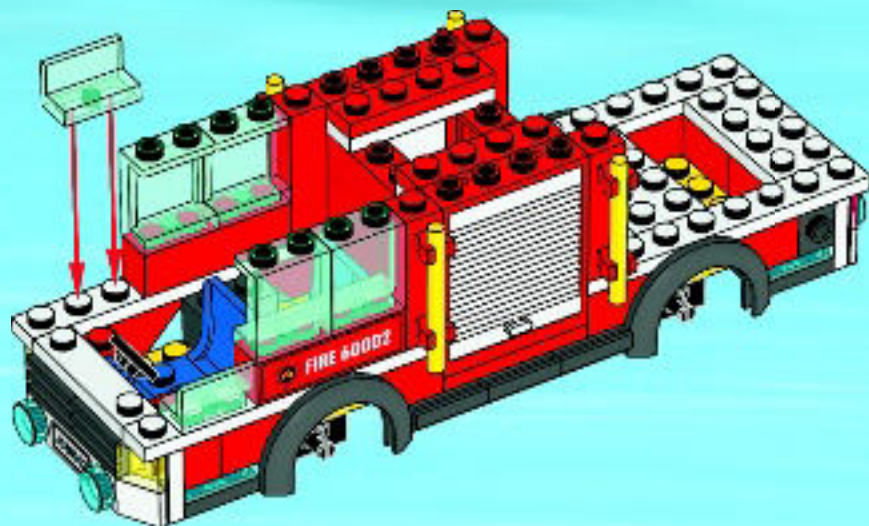





1x

32

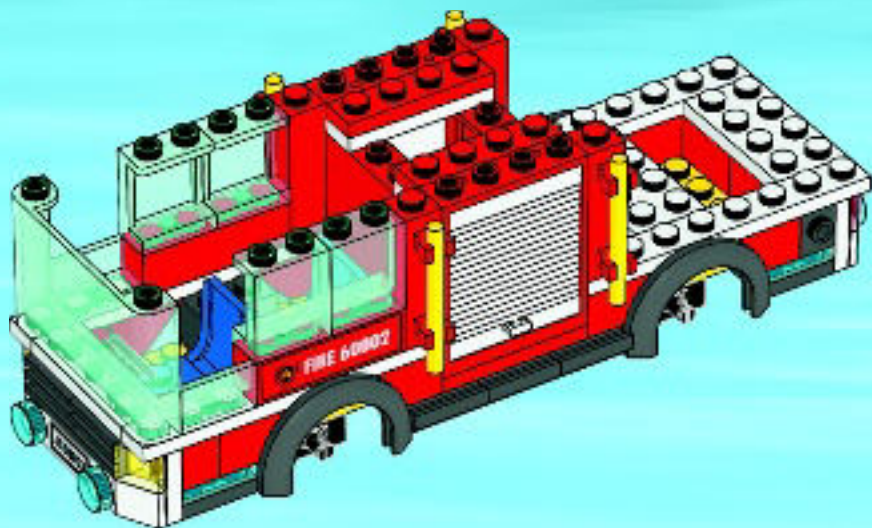



2x

# 33

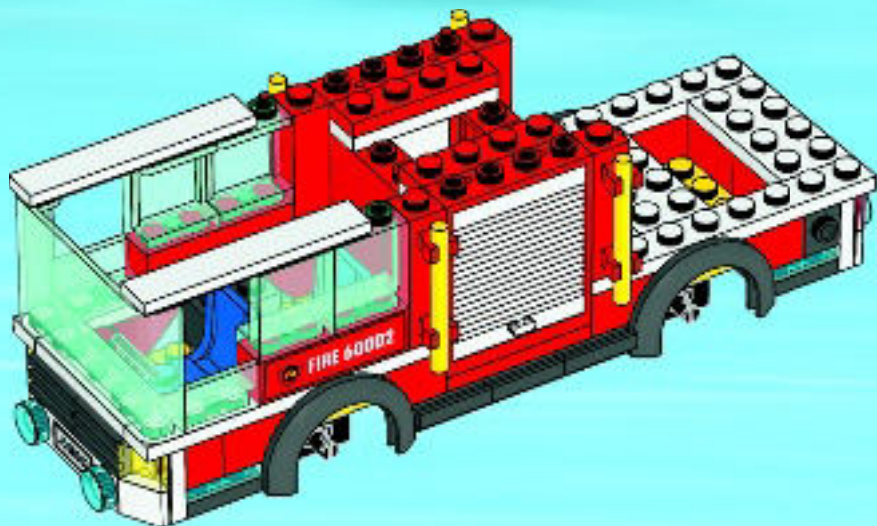



3x

34

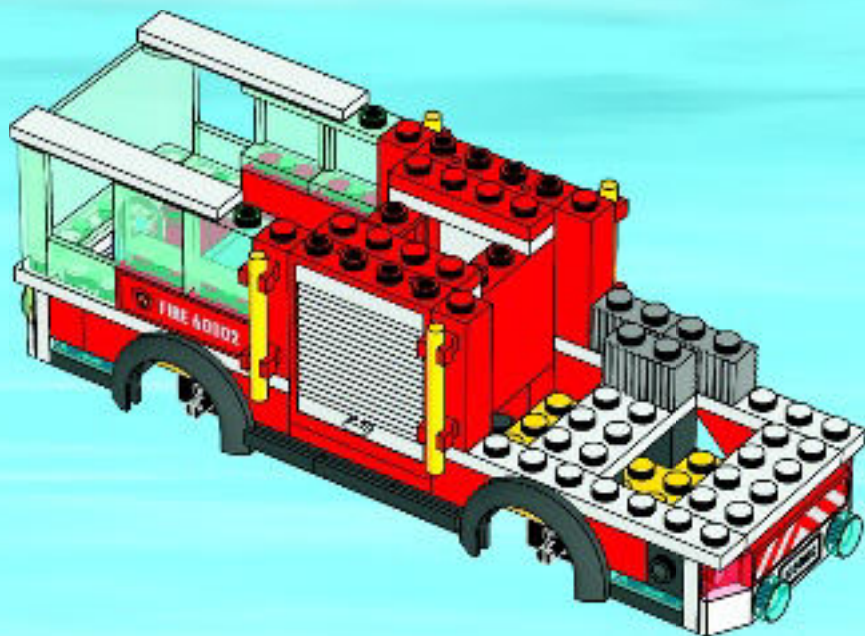



2x

35

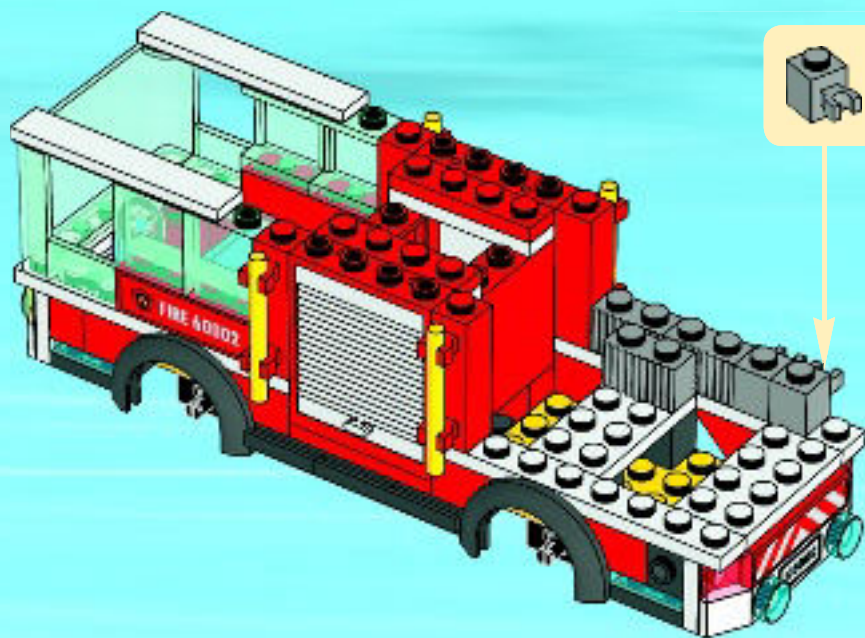



1x

36

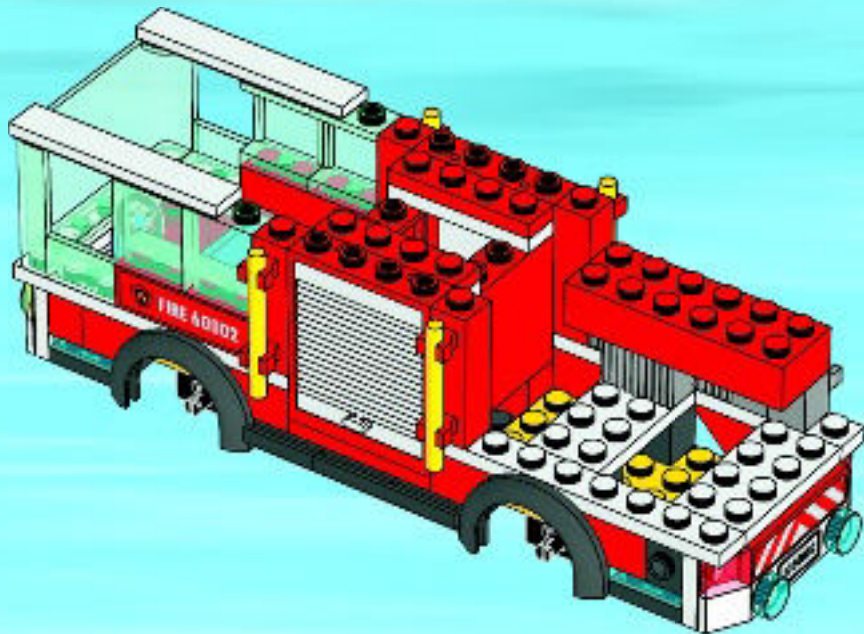



1x



2x

37

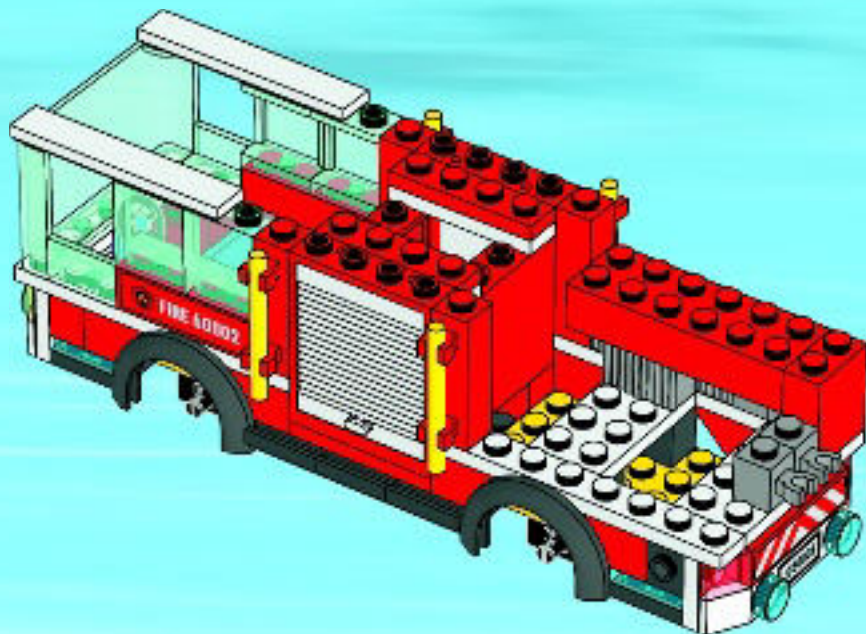



1x



1x



1x

# 38

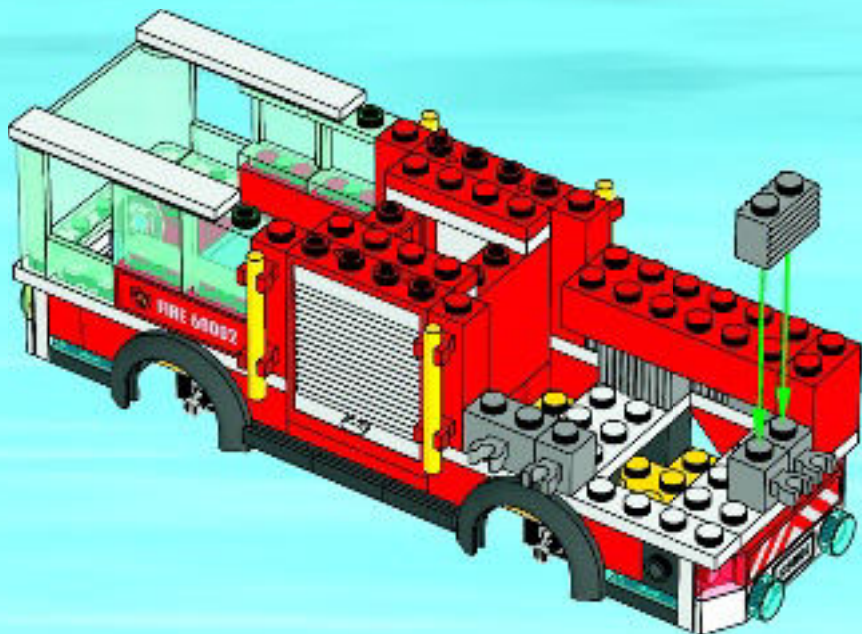



1x

39

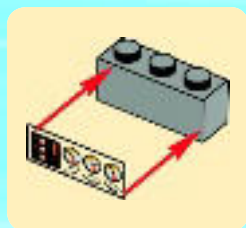
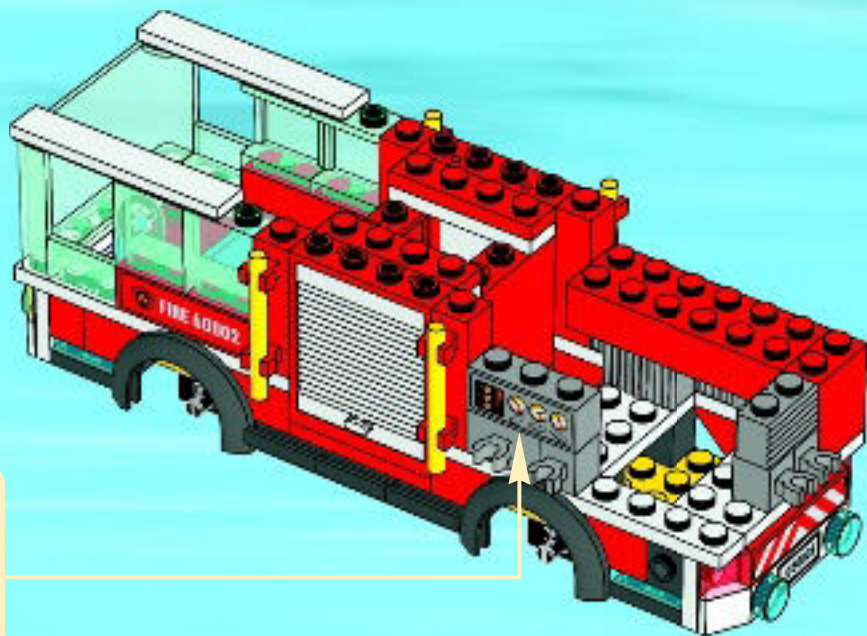





1x

40

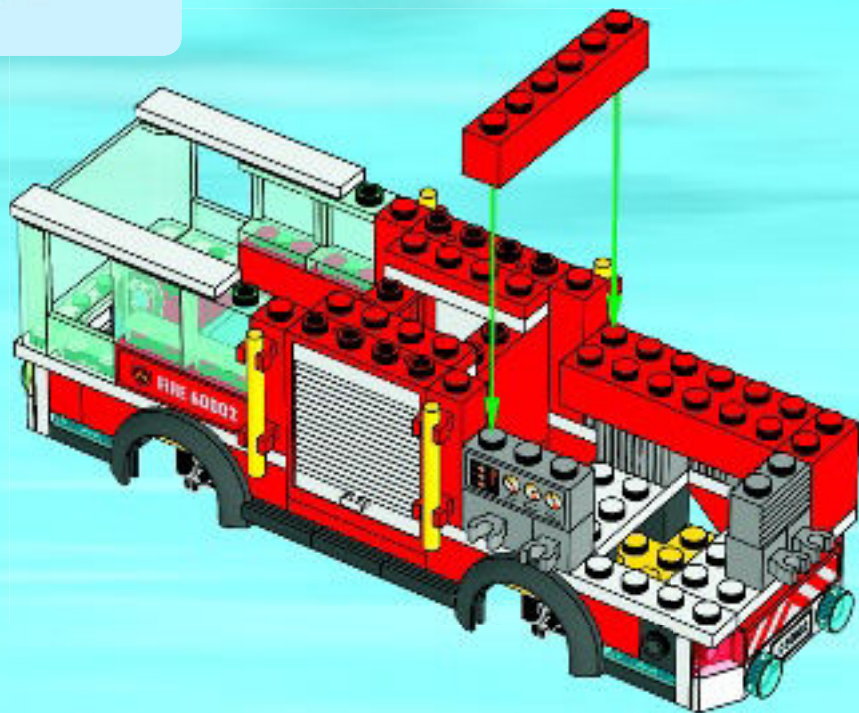

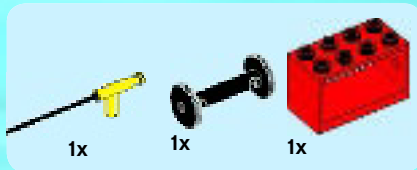

41

1



2

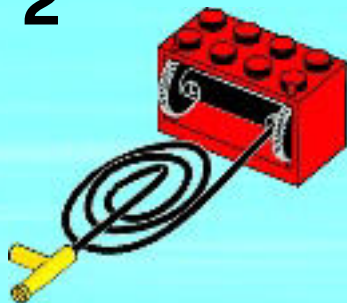

3



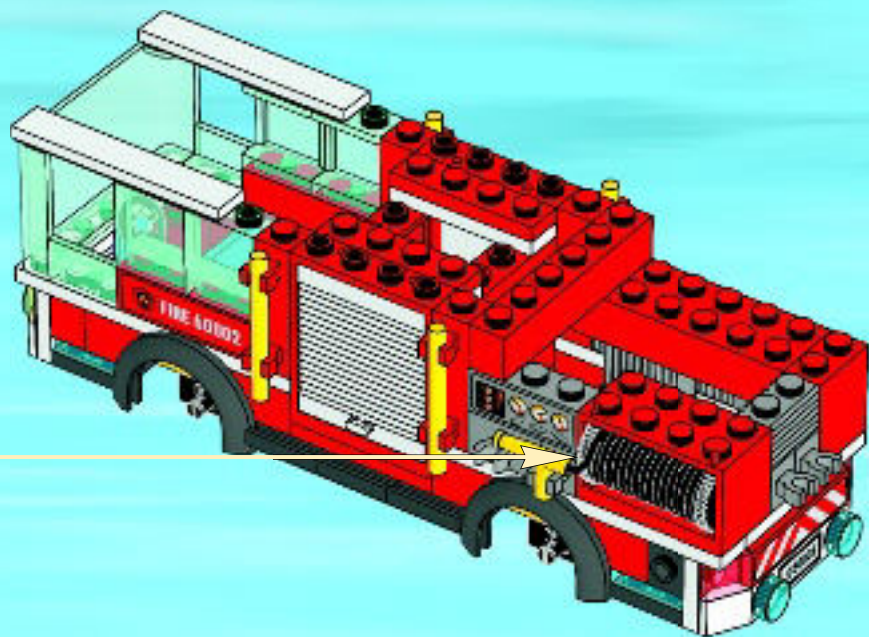



2x

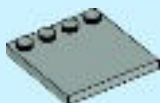

1x

# 42

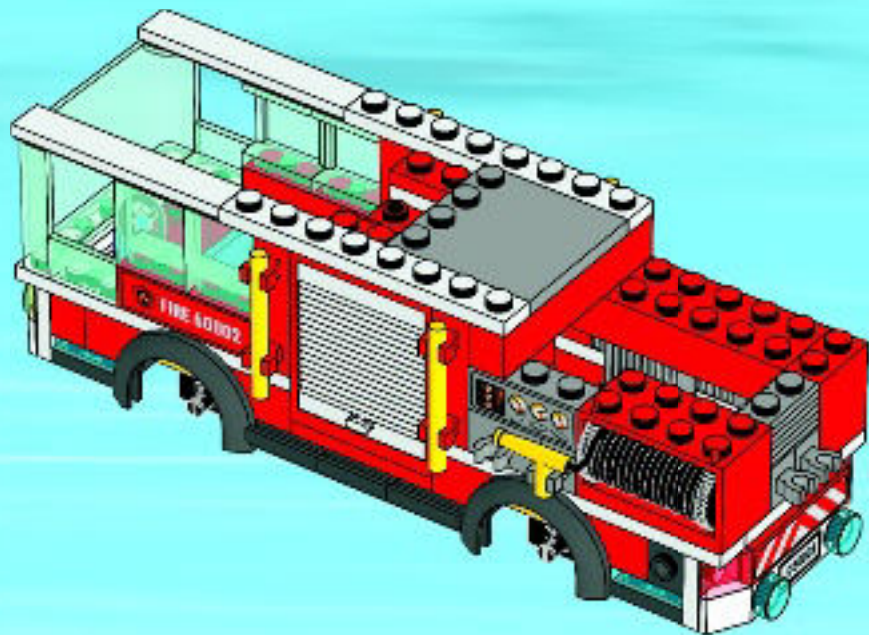



2x



1x

# 43

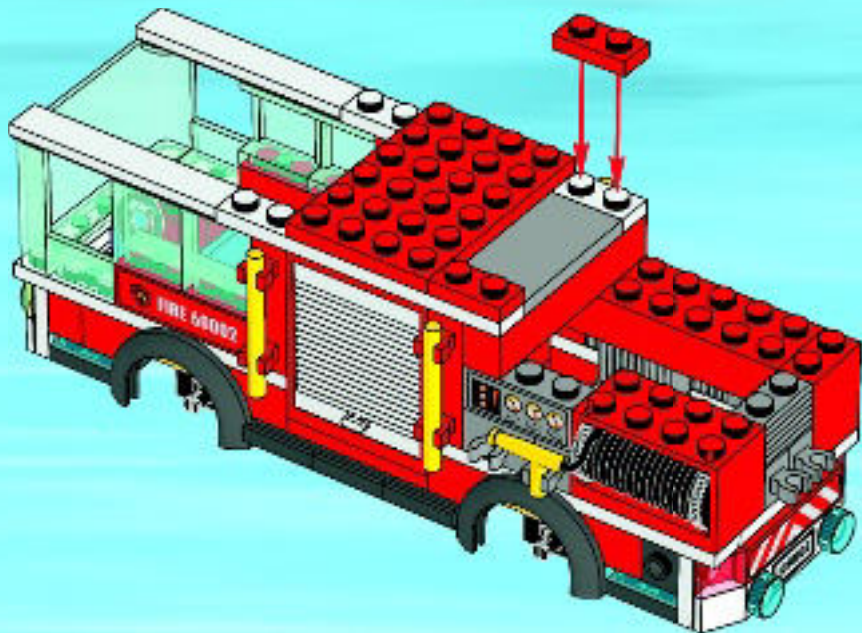



2x



1x



2x



2x



2x



1x

1

44

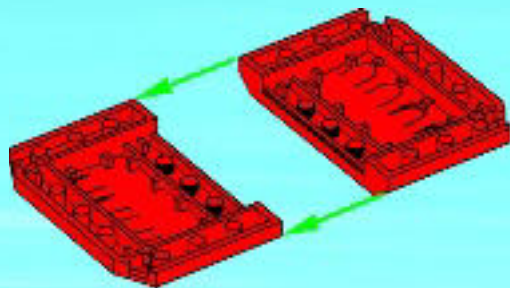

**2**



**3**

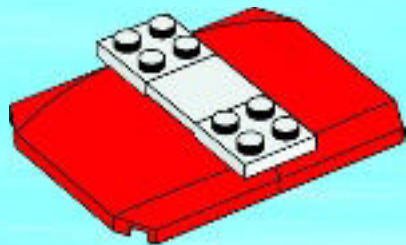

4

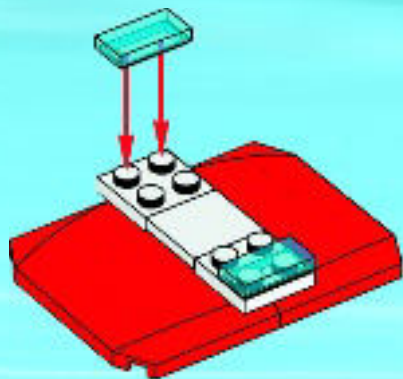

5

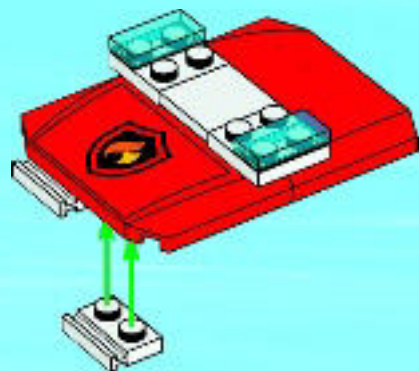



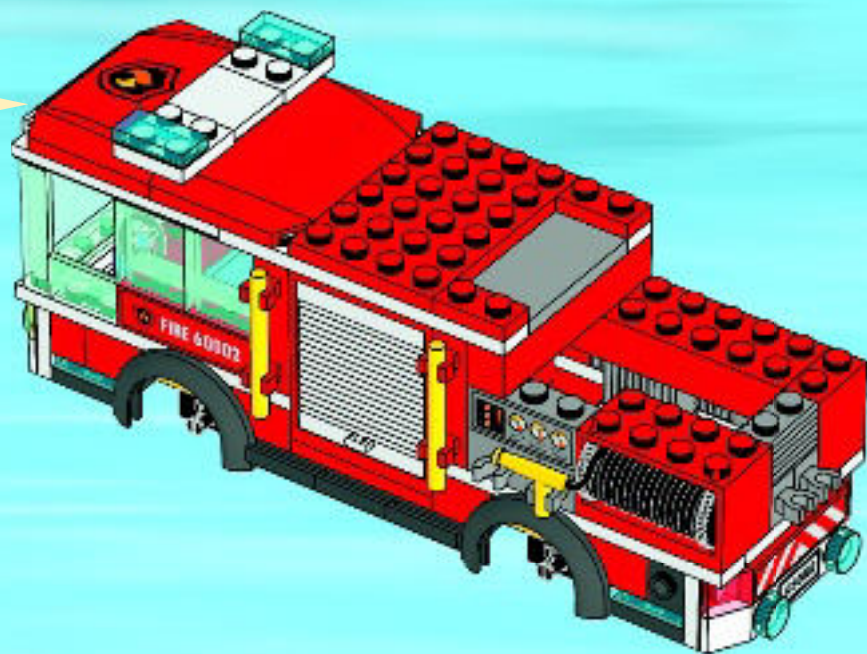



2x



2x

# 45

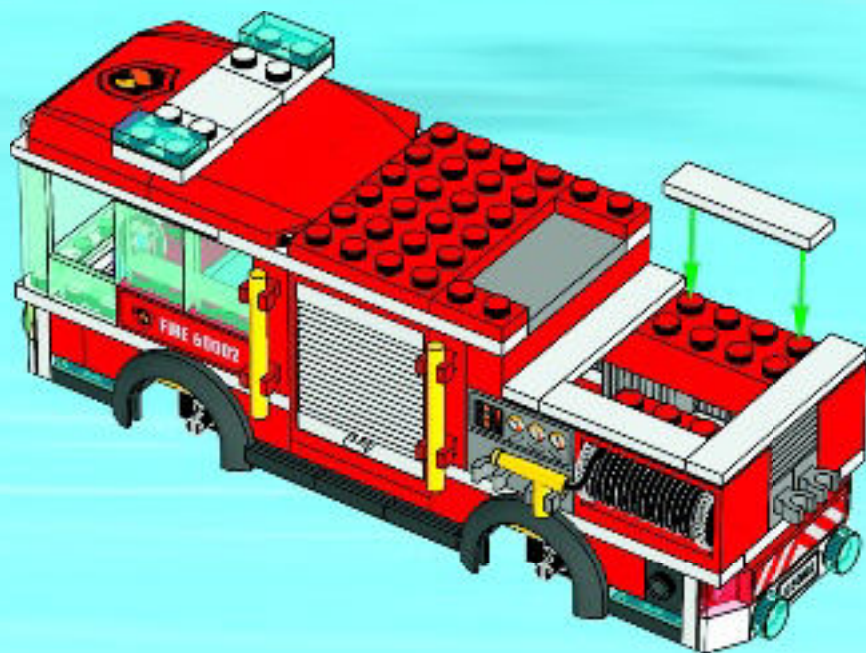



1x



1x

46





**3**

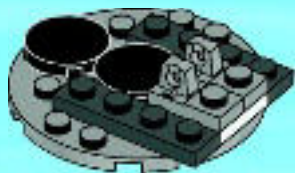

**4**



**5**



6

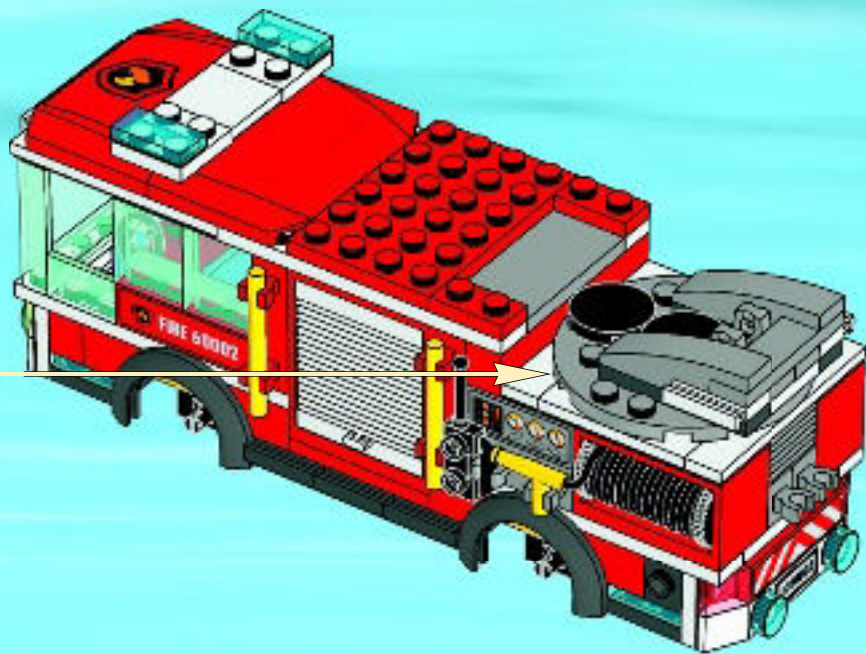

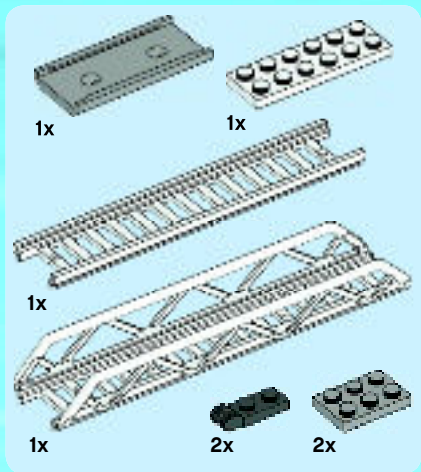

48

1



2

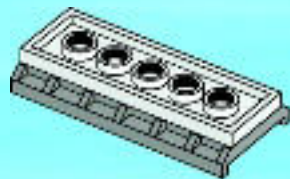

3

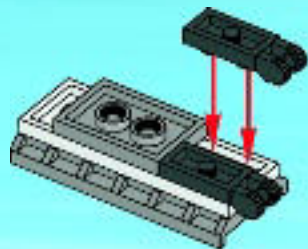

4

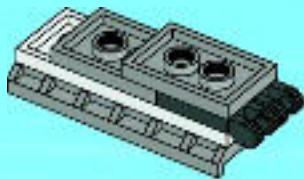

5

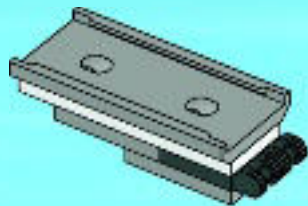



6

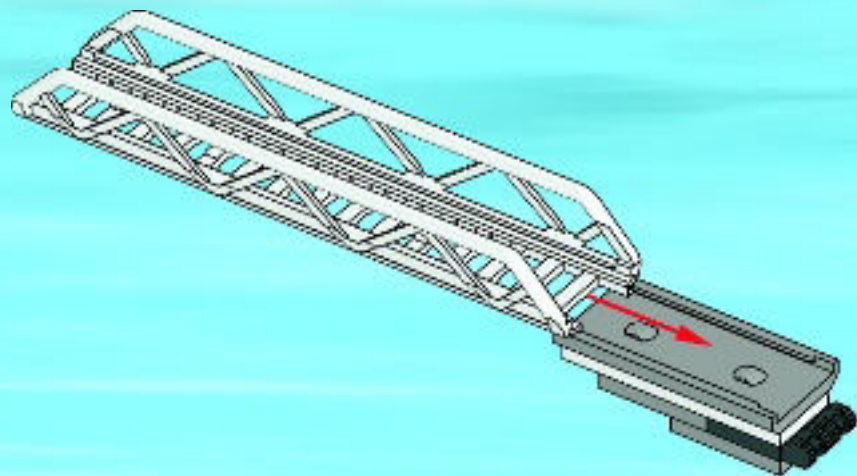

7

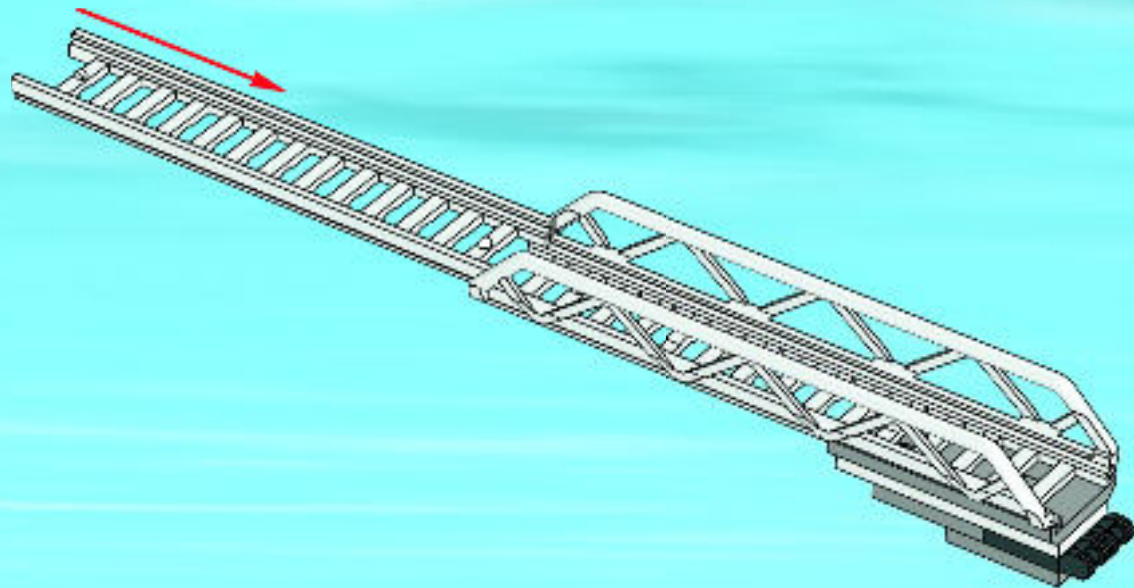

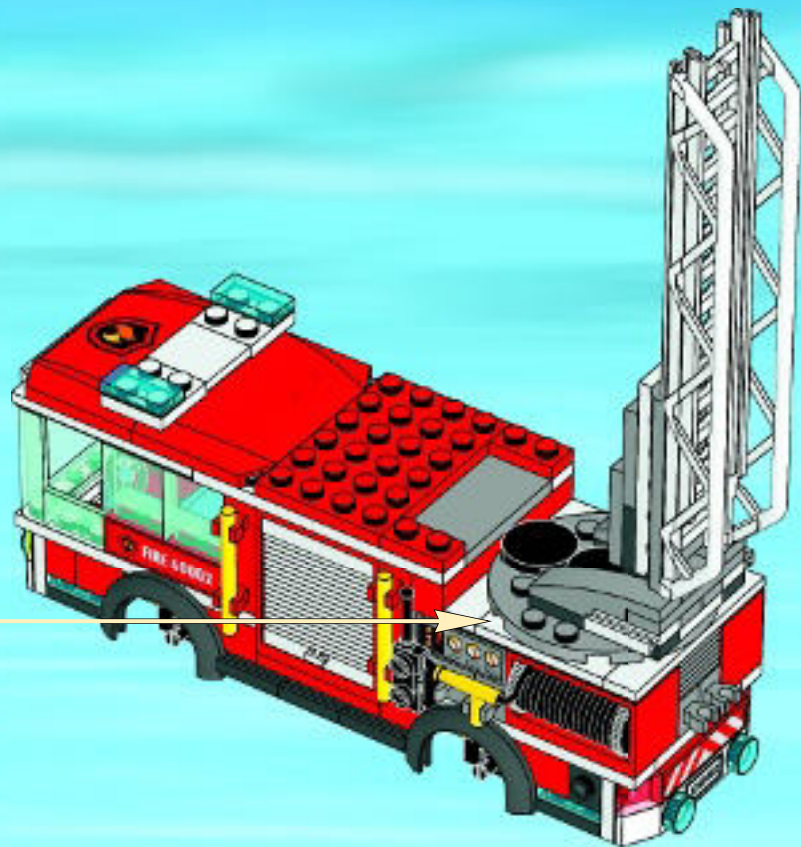

49

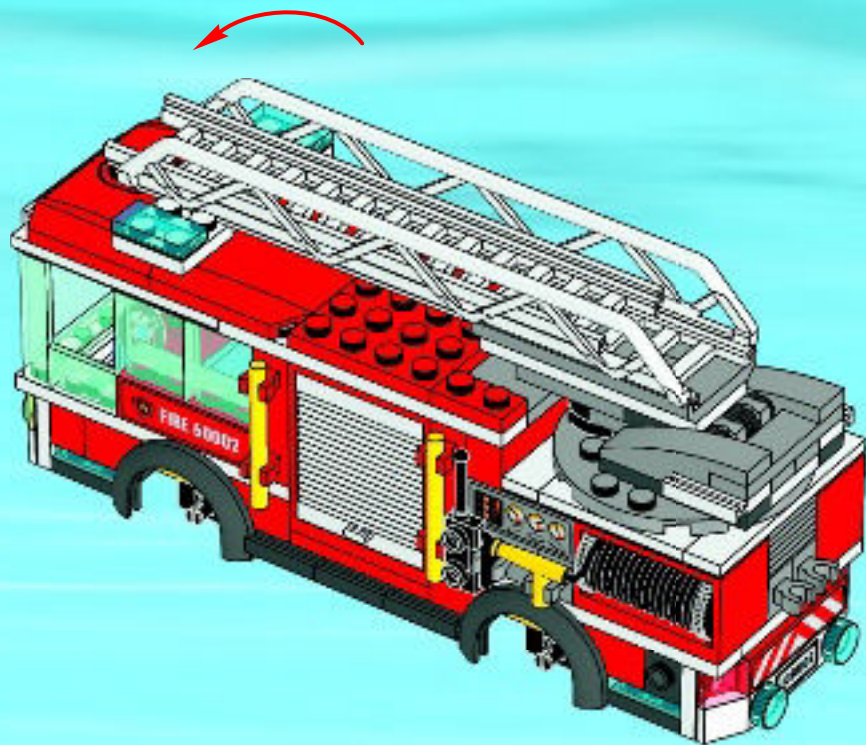



50

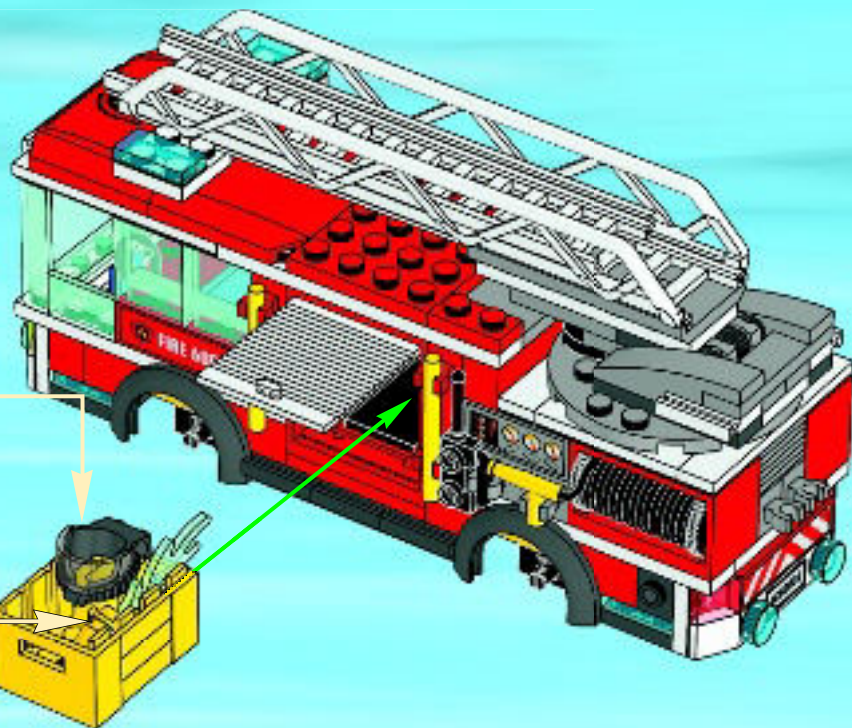
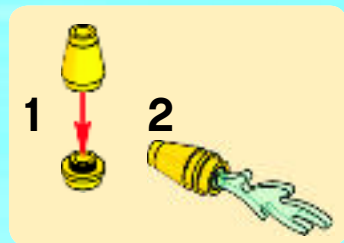



4x



4x

# 51

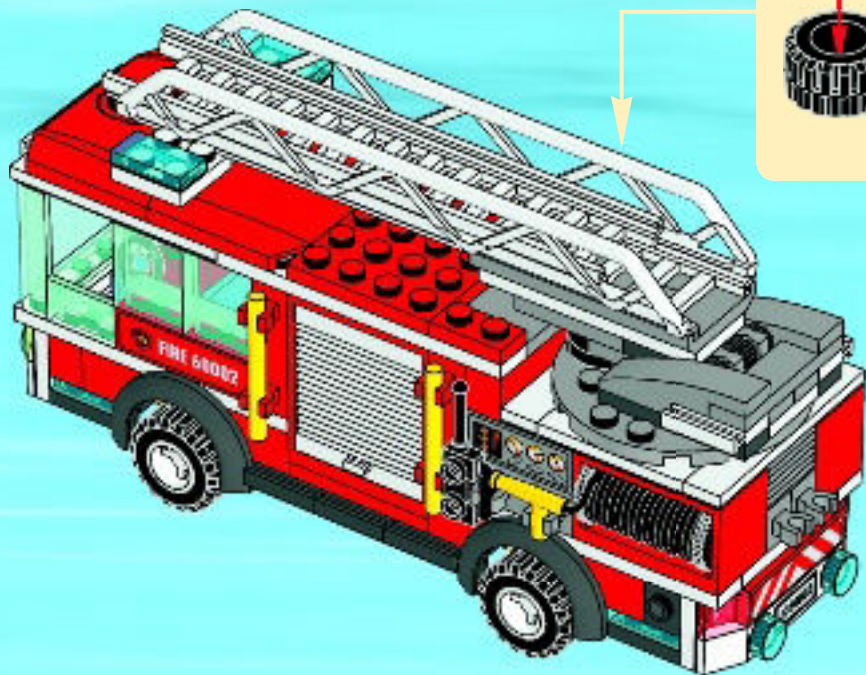

4x



1x



1x



1x



1x



1x

# 52



53







1x

54





CITY



60004



60003



60002



60001



60000

**LEGO**

**CITY**

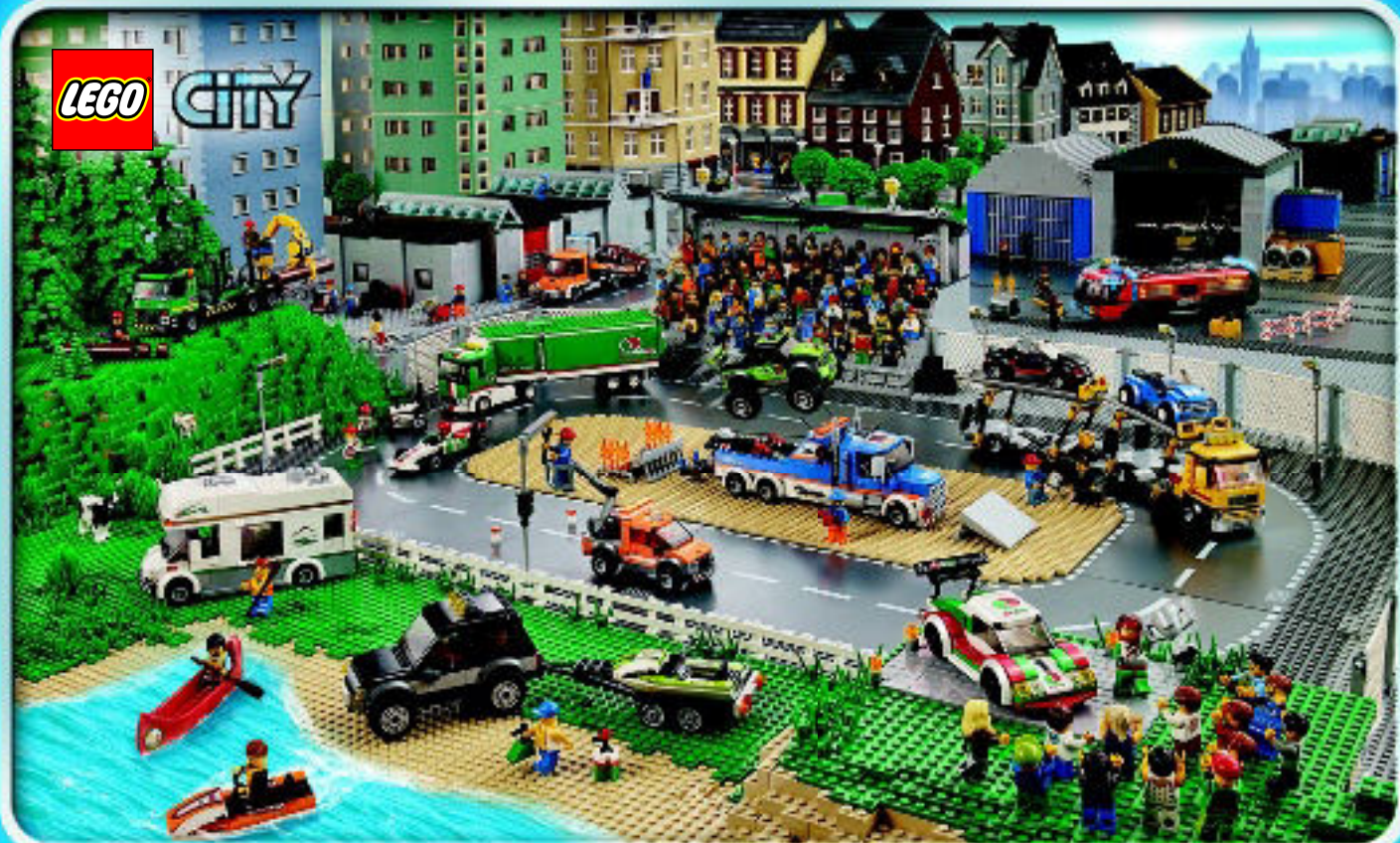



CITY

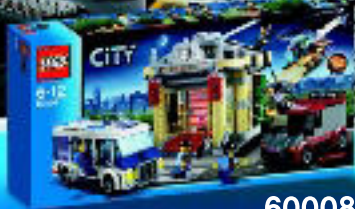

6008



6007



6006













































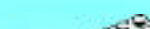









CITY

LEGO.com/city

**EXPLORE TONS OF GAMES,  
MOVIES AND FUN CHALLENGES**

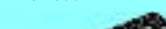

Entdecken viele Spiele, Filme und spannende Herausforderungen  
Découvrez de nombreux films, jeux et défis amusants  
Explora abundantemente juegos, películas y desafíos divertidos  
Explora una increíble variedad de juegos, filmes e oportunidades de divertimento  
Küzzel ki sok-sok játékot, filmet és érdekes kihívást!

- |   |  |  |  |   |  |  |
|---|--|--|--|---|--|--|
| <br>4x<br>4504369    | <br>2x<br>243101    | <br>1x<br>4143832   | <br>8x<br>366521    | <br>2x<br>4262009    | <br>2x<br>303224    | <br>1x<br>4525464   |
| <br>3x<br>302201   | <br>4x<br>663601  | <br>4x<br>301021  | <br>2x<br>302321  |   |  | <br>2x<br>415026  |
| <br>5x<br>4597131 | <br>2x<br>4560929 | <br>1x<br>300921  | <br>8x<br>371021  | <br>2x<br>4259903 | <br>1x<br>4599378 | <br>1x<br>4560182 |
| <br>2x<br>302001  | <br>6x<br>241201  | <br>1x<br>4181138 | <br>1x<br>303221  | <br>1x<br>4261690 | <br>1x<br>6050850 | <br>2x<br>6018684 |
| <br>1x<br>379501  | <br>2x<br>4262006 |  | <br>4x<br>6019155 | <br>2x<br>4558212  | <br>1x<br>4256320 | <br>1x<br>6018496 |
| <br>6x<br>346001  | <br>4x<br>4170457 |  | <br>1x<br>243121  | <br>1x<br>306221   | <br>1x<br>4613418 | <br>1x<br>6018492 |
| <br>4x<br>4249563  | <br>1x<br>420701  |  | <br>4x<br>4563682 | <br>2x<br>407923   | <br>1x<br>6021675 | <br>1x<br>6018492 |
| <br>1x<br>306801   | <br>1x<br>6018585 |  | <br>1x<br>6030266 | <br>1x<br>9566     | <br>1x<br>383824  | <br>1x<br>4517986 |
|   |  |  |  |   | <br>1x<br>306224  | <br>1x<br>303426  |
|   |  |  |  |   | <br>4x<br>4193511 |  |



1x  
396226



1x  
383526



1x  
400626



1x  
4558850



4x  
4568644



4x  
448826



1x  
4262023



1x  
4262022



4x  
4640026



2x  
4618924



1x  
4155537



1x  
4546691



4x  
4260426



2x  
4113854



4x  
4646861



2x  
4260942



1x  
4163306



2x  
4650879



2x  
4244363



1x  
4211428



5x  
4533772



4x  
4211383



1x  
4641682



2x  
4532593



1x  
4599498



1x  
4211837



1x  
4211462



2x  
4219913



1x  
6015349



2x  
4211396



1x  
4565430



4x  
4211525



2x  
4211001



1x  
4211065



2x  
4210631



6x  
4543086



2x  
4210884



2x  
4558955



2x  
4211002



1x  
4211134



4x  
4260124



1x  
4211080



1x  
4261469



1x  
4222042

Customer Service

Kundenservice

Service Consommateurs

Servicio Al Consumidor

LEGO.com/service or dial



: 00800 5346 5555

: 1-800-422-5346



# WIN!

Go to [LEGO.com/productfeedback](http://LEGO.com/productfeedback) to fill out a survey for a chance to win a cool LEGO® Product.

No purchase necessary.  
Open to all residents where not prohibited.



## LEGO.com/productfeedback

### GEWINNE!

Nimm an der Umfrage auf [LEGO.com/productfeedback](http://LEGO.com/productfeedback) teil und hab die Chance ein cooles LEGO® Produkt zu gewinnen!

Die Teilnahme am Gewinnspiel führt zu keinerlei Kaufverpflichtungen. Teilnahme in allen nicht ausgeschlossenen Ländern möglich.

 [LEGO.com](http://LEGO.com)

6084398

### WIN!

Ga naar [LEGO.com/productfeedback](http://LEGO.com/productfeedback), vul een enquêteformulier in en maak kans op een cool LEGO® product.

Geen aankoopverplichting.  
Iedereen mag deelnemen, uitgezonderd ingezetenden van landen waar een enquêteverbod geldt.

### GAGNE!

Visite [LEGO.com/productfeedback](http://LEGO.com/productfeedback) pour répondre à un questionnaire et avoir une chance de gagner un produit LEGO® très cool!

Aucune obligation d'achat.  
Ouvert à tous les résidents des pays autorisés.

### 当てよう!

[LEGO.com/productfeedback](http://LEGO.com/productfeedback) にアクセスして、アンケートにご記入ください。当選者にはレゴ®製品を差し上げます。

お買い上げの必要はありません。  
禁止されていない限り、すべての皆様にご利用いただけます。